



CIRQUE

TECHNISCHES BLATT
SCHEDA TECNICA
DATA SHEET
FICHE TECHNIQUE

CIRQUE

DESIGN MARTINO GAMPER, 2015



Hocker aus Buchenbugholz in zwei Höhen erhältlich. Barhocker auch mit Rückenlehne erhältlich. Sitz aus Schichtholz oder gepolstert. Erhältlich auch mit Ringen aus Metall, Messing matt.

Sgabello in faggio curvato disponibile in due altezze. Lo sgabello alto è disponibile anche con schienale. Seduta imbottita oppure in multistrato. Disponibile versione con cerchi in metallo, finitura ottone satinato.

Bent beech-wood stool in two heights. Barstool version also with backrest. Upholstered or plywood seat available. Also with brushed brass-finish metal rings.

Tabouret en hêtre cintré disponibles en deux hauteurs. Le tabouret bar est également disponible avec un dossier. Assise disponible rembourrée ou en contreplaqué. Version disponible avec anneaux en métal, finition laiton satiné.



SGCIRLLGN
SGCIRLTES

Dimensions mm.
height 970 | width 440 | depth 440



SGCIRMLGN
SGCIRMTES

Dimensions mm.
height 780 | width 440 | depth 440



SGCIRSLGN
SGCIRSTES

Dimensions mm.
height 470 | width 410 | depth 410



SGCIRLLGA
SGCIRLTEA

Dimensions mm.
height 970 | width 440 | depth 440



SGCIRMLGA
SGCIRMTEA

Dimensions mm.
height 780 | width 440 | depth 440



SGCIRSLGA
SGCIRSTEA

Dimensions mm.
height 470 | width 410 | depth 410

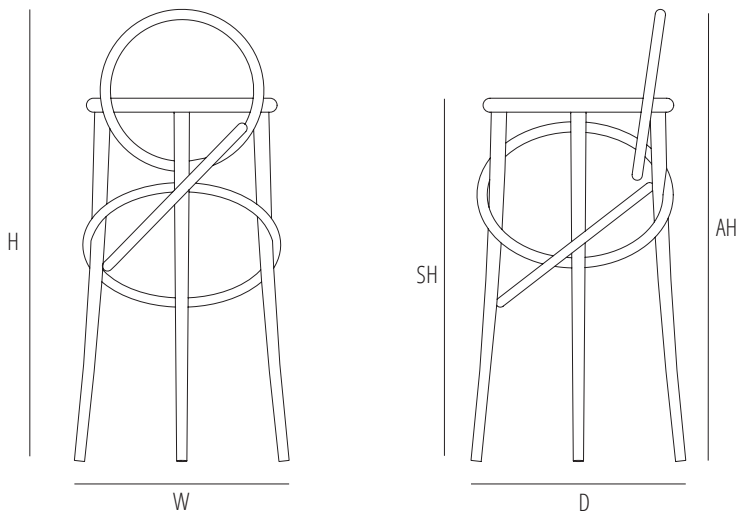

	H	W	D	SH	AH
mm	970	440	440	780	970
inch	38,1	17,3	17,3	30,7	38,1

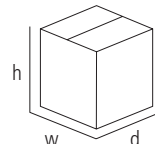
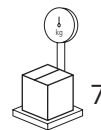
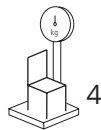
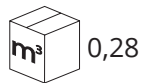
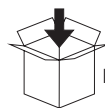

mm - inch
h 1000 - 39,3
w 500 - 19,6
d 550 - 21,6

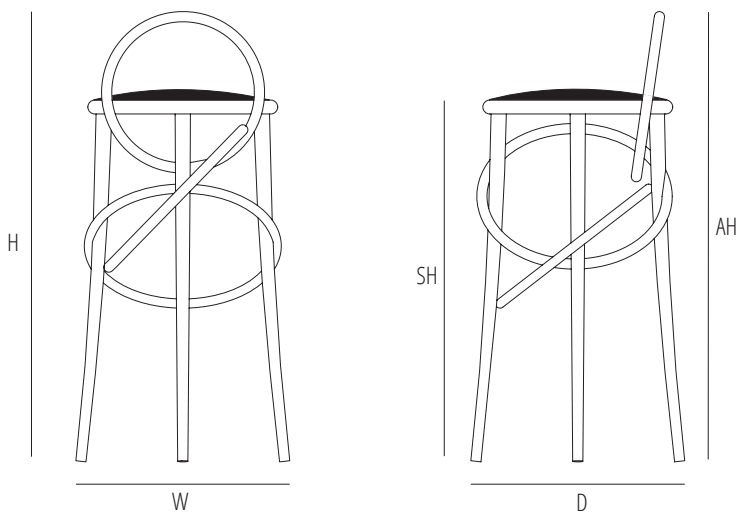

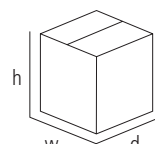
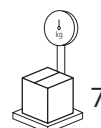
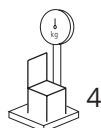
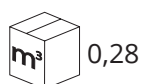
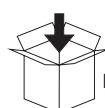

	H	W	D	SH	AH	
mm	970	440	440	780	970	1 Pz/Pc: 40 cm. Linear x 140 cm h/width
inch	38,1	17,3	17,3	30,7	38,1	2 Pz/Pc: 40 cm. Linear x 140 cm h/width

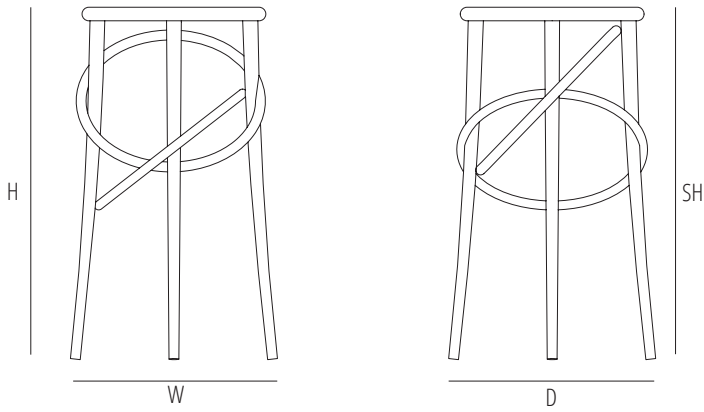

mm - inch
h 1000 - 39,3
w 500 - 19,6
d 550 - 21,6



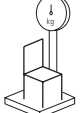
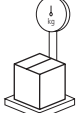
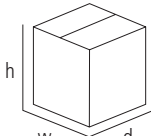

	H	W	D	SH	AH
mm	780	440	440	780	
inch	30,7	17,3	17,3	30,7	

 1
  max. 1
  0,28
  4
  7
 

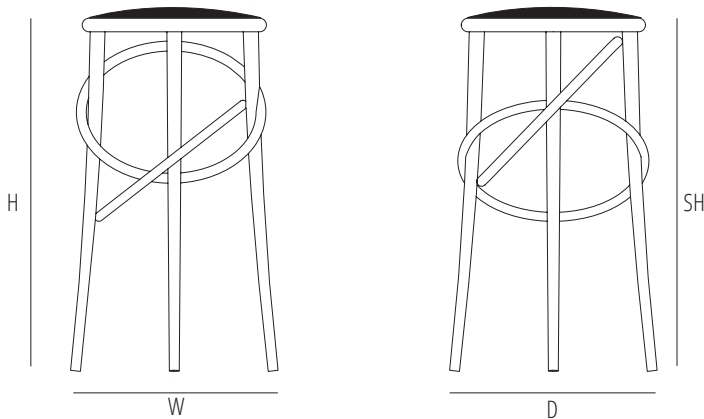
mm - inch
 h 1000 - 39,3
 w 500 - 19,6
 d 550 - 21,6

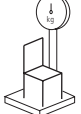
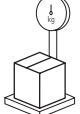
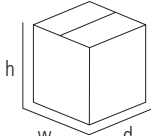

	H	W	D	SH	AH
mm	780	440	440	780	1 Pz/Pc: 40 cm. Linear x 140 cm h/width
inch	30,7	17,3	17,3	30,7	2 Pz/Pc: 40 cm. Linear x 140 cm h/width

 1
  max. 1
  0,28
  4
  7
 

mm - inch
 h 1000 - 39,3
 w 500 - 19,6
 d 550 - 21,6

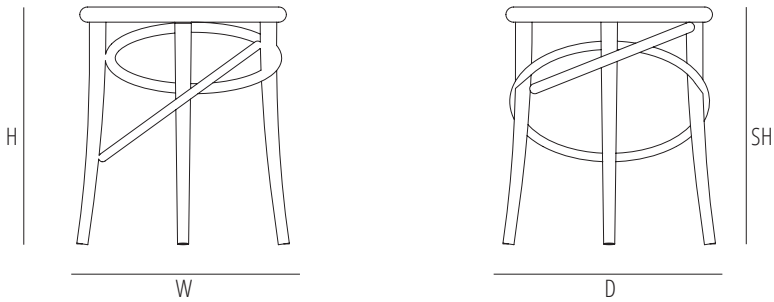

	H	W	D	SH	AH
mm	470	410	410	470	
inch	18,5	16,1	16,1	18,5	

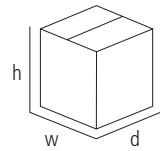
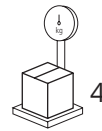
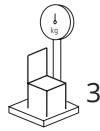
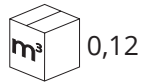

mm - inch
h 540 - 21,2
w 460 - 18,1
d 460 - 18,1

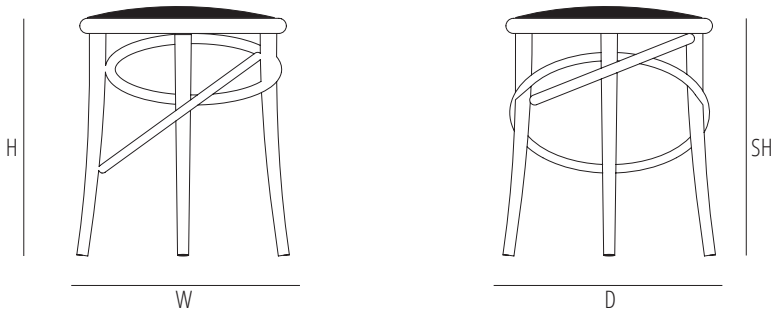

	H	W	D	SH	AH
mm	470	410	410	470	
inch	18,5	16,1	16,1	18,5	

1 Pz/Pc: 40 cm. Linear x 140 cm h/width
2 Pz/Pc: 40 cm. Linear x 140 cm h/width

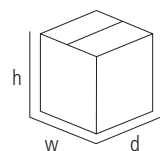
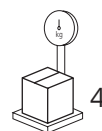
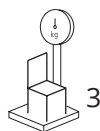
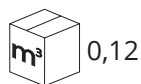

mm - inch
h 540 - 21,2
w 460 - 18,1
d 460 - 18,1

Verfuegbare Ausfuehrungen
Finiture disponibili
Available finishes
Finitions disponibles

TWO TONE

SOLID WOOD / ESSENZE NATURALI + STAINS / TINTI



B01 BEECH
B01 FAGGIO



B03 DARK WALNUT
B03 NOCE SCURO



B03 DARK WALNUT
B03 NOCE SCURO



B01 BEECH
B01 FAGGIO

CLASSIC LACQUER / LACCATO CLASSICO



C01 - RAL 9005 BLACK

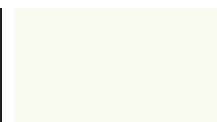

C02 - RAL 9010 PURE WHITE

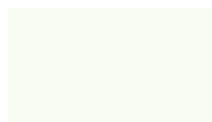

C02 - RAL 9010 PURE WHITE



C01 - RAL 9005 BLACK

Verfuegbare Ausfuehrungen
Finiture disponibili
Available finishes
Finitions disponibles

ONE TONE

SOLID WOOD / ESSENZE NATURALI



B01 BEECH
B01 FAGGIO

STAINS / TINTI



B03 DARK WALNUT
B03 NOCE SCURO



B04 WENGÈ
B04 WENGÈ



B05 BEECH GLOSS O
B05 FAGGIO GLOSS O

CLASSIC LACQUER / LACCATO CLASSICO

*Ash wood is open-pore painted
* L'essenza frassino è verniciata a poro aperto



C01 - RAL 9005 BLACK

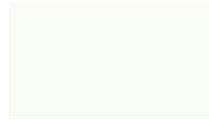

C02 - RAL 9010 PURE WHITE

CONTEMPORARY LACQUER / LACCATO CONTEMPORANEO

*Ash wood is open-pore painted
* L'essenza frassino è verniciata a poro aperto

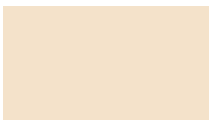

D01 - RAL 1013 PEARL WHITE



D02 - RAL 7047 TELEGREY 4



D03 - RAL 7030 STONE GREY



D19 - S7502 G DARK GREY

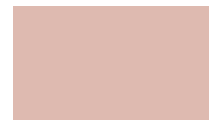

D21 - S1510 Y80R POWDER PINK



D20 - S2570 Y60R ORANGE



D10 - RAL 3000 FLAME RED



D14 - RAL 3005 WINE RED



D22 - S1515 R90B LIGHT BLUE



D11 - RAL 7000 SQUIRREL GREY



D12 - RAL 7031 BLUE GREY



D25 - RAL 5011 STEEL BLUE



D15 - RAL 5020 OCEAN BLUE



D24 - S2070 Y10R YELLOW OCRE



D07 - RAL 1027 CURRY YELLOW



D23 - S6020 G10Y DARK GREEN

Verfuegbare Ausfuehrungen
Finiture disponibili
Available finishes
Finitions disponibles

BRASS RINGS

SOLID WOOD / ESSENZE NATURALI + STAINS / TINTI



B01 BEECH
B01 FAGGIO



B03 DARK WALNUT
B03 NOCE SCURO

CLASSIC LACQUER / LACCATO CLASSICO



C01 - RAL 9005 BLACK

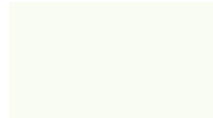

C02 - RAL 9010 PURE WHITE

Gebrüder Thonet Vienna GmbH
Prinz Eugen Straße 42
1040 Wien (AT)

www.gebruederthonetvienna.com

Offices of the trademarks' licensee
Production Furniture International S.p.A.
Via Foggia, 23/H
10152 Torino (TO) Italy

Phone: 0039 011 0133330 - info@gebruederthonetvienna.com