



Table made in solid wood, its top is glued lists and straight sides, with a central iron compartment to store objects. The top is supported by four legs with a geometrical section.

STANDARD VERSION: IRON CENTRAL PROFILE LACQUERED IRONDUST COLOUR (B2); LEGS IN GLUED LISTS OF SOLID WOOD

CODE	SIZE	A1	A2	A3	A4
CANAL 1	W.220 x D.110 x H.76,8	■	■	■	■
CANAL 2	W.240 x D.110 x H.76,8	■	■	■	■
CANAL 3	W.260 x D.110 x H.76,8	■	■	■	■

AVAILABLE FINISHES:

- A1:** walnut without knots, walnut with knots, elm
- A2:** oak without knots, oak with knots, cherry, maple
- A3:** oak without knots finish: whitened, mystic black, vintage, neutro
oak with knots finish: whitened, mystic black, vintage, neutro
- A4:** oak without knots pigmented: total black
oak with knots pigmented: total black

FEASIBILITY LACQUERED IRON CENTRAL PROFILE	
B2	■
B3	■

AVAILABLE FINISHES:

- B2:** lacquered iron: irondust, RAL (only selected colours)
- B3:** lacquered iron matt brushed effect: aged copper, aged bronze, stainless steel, titanium
lacquered iron oxidised effect

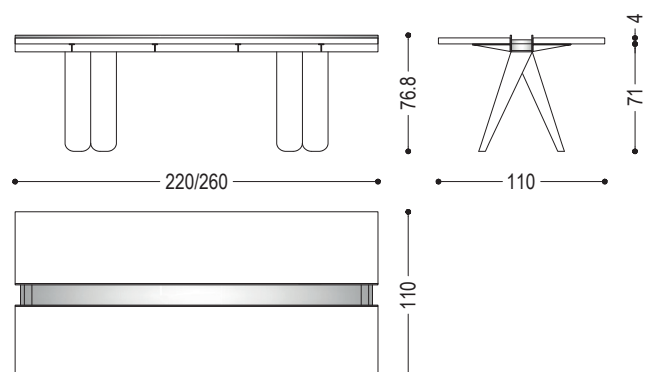

WOOD

A1



walnut without knots



walnut with knots



elm

A2



oak without knots



oak with knots



cherry



maple

A3



oak without knots finish:
whitened



oak without knots finish:
mystic black



oak without knots finish:
vintage



oak without knots finish:
neutro



oak with knots finish:
whitened



oak with knots finish:
mystic black



oak with knots finish:
vintage



oak with knots finish:
neutro

A4













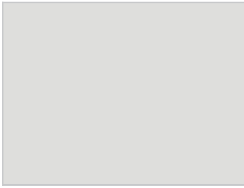

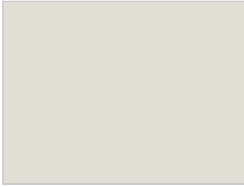

oak without knots pigmented:
total black



oak with knots pigmented:
total black

IRON

B2					
	lacquered iron: iron dust	ferro laccato: RAL - 1013_OYSTER WHITE	ferro laccato: RAL - 3020_TRAFFIC RED	ferro laccato: RAL - 7035_LIGHT GREY	ferro laccato: RAL - 7037_DUSTY GREY
					
	ferro laccato: RAL - 8019_GREY BROWN	ferro laccato: RAL - 9001_CREAM WHITE	ferro laccato: RAL - 9002_GREY WHITE	ferro laccato: RAL - 9005_JET BLACK	ferro laccato: RAL - 9010_PURE WHITE
					
	ferro laccato: RAL - 9016_TRAFFIC WHITE				
B3					
	lacquered iron, matt brushed effect: aged copper	lacquered iron, matt brushed effect: aged bronze	lacquered iron, matt brushed effect: stainless steel	lacquered iron, matt brushed effect: titanium	lacquered iron, oxidised effect