

BONALDO

Flac

Designer: **Fabrice Berrux**



Flac is the name of the new collection of coffee tables designed by Fabrice Berrux for Bonaldo, available in three heights and three diameters (Flac low, Flac medium, Flac high). The characterizing element is the fused and tempered glass top which gives the effect of the surface of water: the top floats on a slender metal base which almost appears to be the mounting for a precious stone. The different heights at which the tables are offered allow the creation of interesting

compositions, characterized by a subtle interplay of superimpositions which highlight different shades of colour in the intersection of the glass. In the medium and low versions, the top is also available in wood, ceramic and marble, for a mix & match of materials that make Flac a versatile and perfect element for every style. The metal base features an cross-joint between the legs, an element of craftsmanship that enhances the lightweight design of the product.



Data sheet

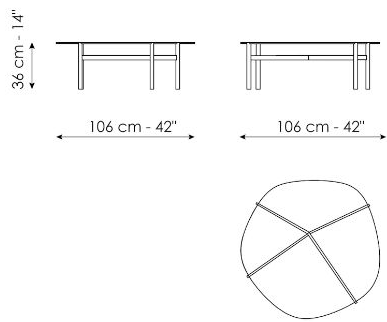

Flac high

Width: 106cm
Depth: 106cm
Height: 36cm

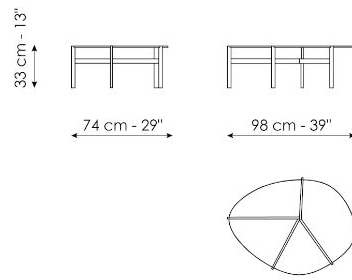

Flac medium

Width: 98cm
Depth: 74cm
Height: 33cm

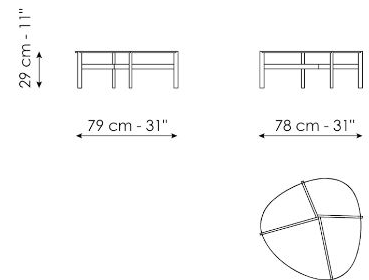

Flac low

Width: 79cm
Depth: 78cm
Height: 29cm

Finishes

TOP

Glass



Tempered cast glass
Bronzed



Tempered cast glass
Smoked

Ceramic



Mat ceramic
Alaska White



Mat ceramic
Ardesia grey



Mat ceramic
Augusta



Glossy ceramic
Black Onyx



Glossy ceramic
Calacatta



Silk finish ceramic
Calacatta macchia
vecchia



Glossy ceramic
Imperial grey



Mat ceramic
Laurent



Glossy ceramic
Mountain peak

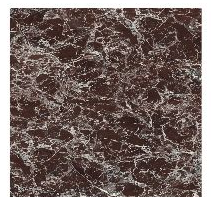

Glossy ceramic
Rosso imperiale

Marble



Marble
Calacatta



Marble
Carrara

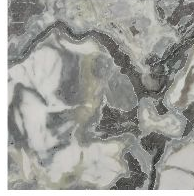

Marble
Dover White



Marble
Emperador



Marble
Fior di bosco

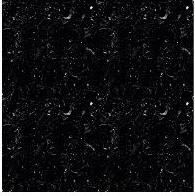

Marble
Marquinia



Marble
Rosso Carpazi

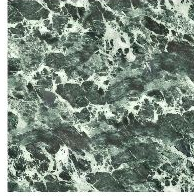

Marble
Saint Denis



Marble
Travertino Romano

Wood



Veneered wood
Walnut Canaletto



Veneered wood
Coal oak

